

Manual Installation/User

(HSRadStat) Non-Programmable



Application:

Hydronic Heating, Connections R,W,C to be connected to Zone by Pump, Valve, Actuator Controllers.

Specifications:

- Power Supply: 24Vac 60Hz
- Temperature Setting Range: + - 1 Deg F
- Temperature Accuracy: + - 1 Deg F
- Power Consumption: < 2 Watts
- Grade of protection: IP 30
- Installation Type: Surface Mount

User Guide:

On/Off: Press power button to switch ON and OFF thermostat.

Temperature Setting: Press "▼" to reduce temperature "▲" to raise temperature.

Mode: Press "M" to change mode between cool , heat , mode will be confirmed by pressing other button or automatically after 6 seconds.

Fan: Press "+" to fan (ON) or (Auto), On means when the room temperature reach the setpoint.

Backlight: Any key press will activate the backlight. Backlights will timeout 6 seconds after last key press.

Keypad Lockout: (Only available when item 11 set to (1),(2),(3) for 3 seconds to lock the buttons and press "▼" and "▲" for 3 seconds to unlock.

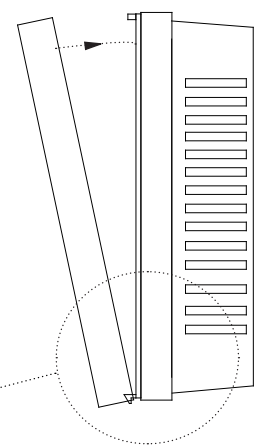
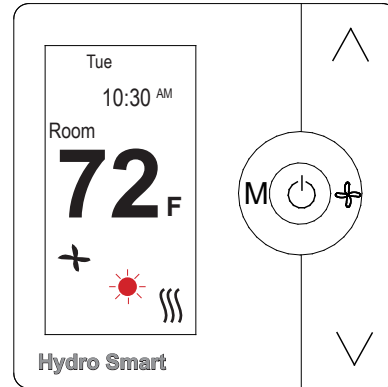

To **install** display to base. Position display slots into base hooks then rotate to snap into place.

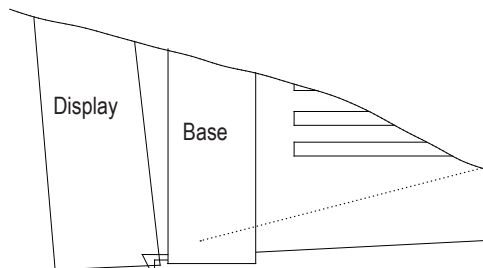

Wiring Diagram:

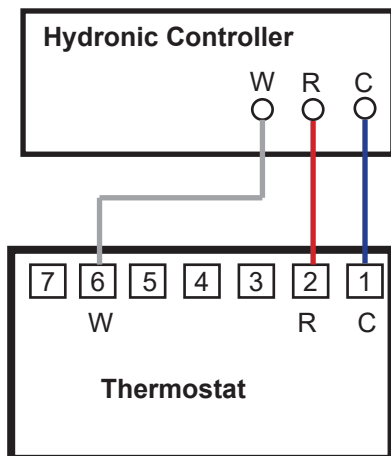

Mounting and Installation:

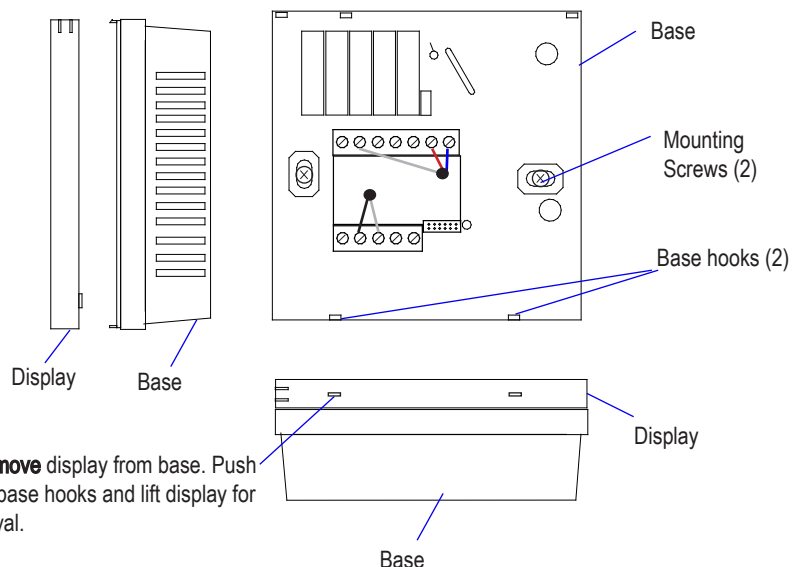





To **remove** display from base. Push back base hooks and lift display for removal.

Parameter Table Explanation

- 1 **System Type:** Selectable system type is AC or HP. Default is A/C
- 2 **Auto Mode:** Manual or auto season changeover
- 3 **Sensor Type:** (1) Internal sensor only. (2) External sensor only
- 4 **Reserved:** Not available
- 5 **Unoccupied Status:** When the Hotel card is pulled out. The unoccupancy status will be (0) No output. (1) Thermostat will work in energy saving mode with setback setpoint and Fan will operate at low speed.
- 6 **Temperature Display:** Choose between showing room temperature ((0) or setpoint (1). Default is room temperature (0).
- 7 **Display Temp. Adjustment:** You can calibrate the room temperature by the range +4 to -1F
- 8 **Deadband:** The heat will be only activated if the differential temperature between setpoint and room temperature < the dead band. For example under heating mode the set point is 70F with dead band 1F. The will be only available < 69F.
- 9 **Reserved:** Not available
- 10 **Reserved:** Not available
- 11 **Keypad Lock:** Keypad lock can be set to 4 status for different people operation. The symbol  will show on the screen.
- 12 **Power Up Status:** When power supply failed and back up again. The thermostat will follow three status. (0) keep system off. (1) keep system original staus before the power failure. (2) Switch system on automatically.
- 13 **Energy Savings Dry Contact:** Not available
- 14 **Freeze Protection:** In freeze protection mode when thermostat is off modewhile the acquired temperature is below 41F. The thermostat will start heat mode until the thermostat rises to 43F.
- 15 **Programmable:** Not available
- 16 **Reserved:** Not available
- 17 **Minimum Setpoint:** You can set the minimum setpoint to save energy.
- 18 **Cooling Setpoint Setback:** Under Energy Savings mode (when option 13 activates). The thermostat will set the setpoint as setback temperature for energy saving.
- 19 **Maximum Setpoint:** You can set the maximum setpoint to save energy.
- 20 **Heating Setpoint Setback:** Under Energy Savings mode (when option 13 activates). The thermostat will set the setpoint as setback temperature for energy saving.
- 21 **Heat Delay:** Not available
- 22 **Compress Protection:** Not available
- 23 **Fahrenheit/Celsius:** Thermostat can operate on Farenheit or Celsius. The default is Farenheit.
- 24 **H/C:** Not available

Paramater Settings

Switch off the thermostat “” and Press “M” and “” Simultaneous for 5 sSeconds to enter parameter settings menu. Press “M” or “” to change the item. Press the “” and “” to change the value after you finish with setting adjustments. The thermostat will the adjusted settings and switch off in 20 econds automatically.

Parameter Table

1	System Type	A/C or HP (Default AC)
2	Auto Mode	0 - Manual (Default) 1 - Auto
3	Sensor Type	1 - Internal Sensor (Default) 2 - External Sensor Only
4	Reserved	Reserved
5	Unoccupied Status	0 - Cut Off All Outputs 1 - Show Setpoint (Default)
6	Temperature Display	0 - Show Room Temperature (Default) 1 - Show Setpoint
7	Display Temp. Adjustment	+4 to -4F (Default - 0F)
8	Dead Band	1-4 F (Default - 2F)
9	Reserved	Reserved
10	Reserved	Reserved
11	Key Pad Lockout	0 - All Keys Available 1 - All Buttons Locked Out 2 - System Button Locked Out 3 - All Buttons Locked Out Except System
12	Power Up Status	0 - System Off (Default) 1 - System Last State Before Power Off 2 - System On
13	Energy Saving - Dry Contact	N/A
14	Freeze Protection	0 - Disable (Default) 1 - Enable
15	Programmable	N/A
16	Reserved	Reserved
17	Minimum Setpoint	41 - 64F (Default - 41F)
18	Cooling Setpoint Setback	72 - 90F (Default - 90F)
19	Maximum Setpoint	68 - 99F (Default - 95F)
20	Heating Setpoint Setback	50 - 70F (Default - 64F)
21	Heat Delay	N/A
22	Compressor Protection	N/A
23	Fahrenheit/Celsius	F/C (Default Farenheit)
24	H/C	N/A

